

JET
Power Chairs

JET
Power Chairs

JET
Power Chairs

JET
Power Chairs

JET
Power Chairs

JET
Power Chairs

JET
Power Chairs

JET
Power Chairs

JET
Power Chairs

JET 3

Owner's Manual

ATTENTION:
Please read the content
of your owner's manual
before operating your
power chair.



Stylish Design and Premium Performance

Pride
Mobility Products Corp.

Exeter, PA
St. Catharines, ON

1-800-800-8586

www.pridemobility.com

SAFETY GUIDELINES

Please read and follow all instructions in this owner's manual before attempting to operate your power chair for the first time. If there is anything in this manual you do not understand, or if you require additional assistance for set-up, contact your authorized Pride provider.

Using your Pride product safely depends upon your diligence in following the warnings, cautions, and instructions in this owner's manual. Using your Pride product safely also depends upon your own good judgement and/or common sense, as well as that of your provider, caregiver, and/or healthcare professional. Pride is not responsible for injuries and/or damage resulting from any person's failure to follow the warnings, cautions, and instructions in this owner's manual. Pride is not responsible for injuries and/or damage resulting from any person's failure to exercise good judgement and/or common sense.

The symbols below are used throughout this owner's manual to identify warnings and cautions. It is very important for you to read and understand them completely.



WARNING! Failure to heed the warnings in this owner's manual may result in personal injury.



CAUTION! Failure to heed the cautions in this owner's manual may result in damage to your power chair.

C O N T E N T S

I. INTRODUCTION	4
II. SAFETY	6
III. EMI/RFI	14
IV. THE JET 3	16
V. COMFORT ADJUSTMENTS	21
VI. DISASSEMBLY	25
VII. BATTERIES AND CHARGING	26
VIII. OPERATION	30
IX. CARE AND MAINTENANCE	37
X. OPTIONS AND ACCESSORIES	43
XI. WARRANTY	44

*Nitrusdale
Wheelchairs*

I. INTRODUCTION

INTRODUCTION

Welcome to Pride Mobility Products Corporation (Pride). Congratulations on the purchase of your new Pride Power Chair. The Pride Power Chair design combines the most advanced state-of-the-art components with modern, attractive styling. We are certain that the design features and trouble-free operation of your new power chair will add convenience to your daily living. Nithsdale Wheelchairs

At Pride, your safety is important to us. Please read and follow all of the instructions in this manual before you attempt to operate your power chair for the first time. These instructions were produced for your benefit. Your understanding of these instructions is essential for the safe operation of your new power chair.

Pride is not liable for damage to property or personal injury arising out of unsafe use of a power chair. Pride is also not liable for any property damage or personal injury arising out of the failure of any person and/or user to following the instructions and recommendations set forth in this manual or any other instructions or recommendations contained in other power chair related literature issued by Pride or contained on the power chair itself.

This owner's manual is compiled from the latest specifications and product information available at the time of publication. We reserve the right to make changes as they become necessary. Any changes to our products may cause slight variations between the illustrations and explanations in this manual and the product you have purchased.

If you experience any problems with your power chair that you are unable to solve, or if you do not feel capable of safely following any of the instructions and/or recommendations as contained in this manual, please contact your authorized Pride provider for assistance.

Once you understand how to operate and take care of your power chair, we are certain that it will give you years of trouble-free service and enjoyment.

Information Exchange

We want to hear your questions, comments, and suggestions about this manual. We would also like to hear about the safety and reliability of your new power chair, and about the service you received from your authorized Pride provider.

Please notify us of any change of address, so we can keep you apprised of important information about safety, new products, and new options that can increase your ability to use and enjoy your power chair. Please feel free to contact us at the address below:

Pride Mobility Products Corporation
Attn: Customer Care Department
182 Susquehanna Avenue
Exeter, PA 18643-2694
customer care@pridemobility.com
800-424-8205

I. INTRODUCTION

Pride Owners Club

As an owner of a Pride product, you are invited to register your product's warranty and enroll in the Pride Owners Club. You may do so by filling out and returning your enclosed registration card or by visiting Pride's web site at www.pridemobility.com. As a registered member, each time you visit our site, you will have access to the most interactive and honest educational venue available today for people with mobility needs, their families, and friends.

From our home page, select "Owners Club" to enter a page dedicated to current and potential Pride product owners. You will gain access to interviews, stories, recreation ideas, daily living tips, product and funding information, and interactive message boards. These message boards invited you to communicate with other Pride customers as well as Pride representatives who are available to assist you with any questions or concerns you may have.

My Authorized Pride Provider Is:

Name: _____

Address: _____

Phone Number: _____

Purchase Date: _____

NOTE: If you ever lose or misplace your product registration card or your copy of this manual, contact us and we will be glad to send you a new one immediately.

II. SAFETY

SAFETY



WARNING! Do not operate your new power chair for the first time without completely reading and understanding this owner's manual.

Your power chair is a state-of-the-art life-enhancement device designed to increase mobility. Pride provides an extensive variety of products to best fit the individual needs of the power chair user. Please be aware that the final selection and purchasing decision regarding the type of power chair to be used is the responsibility of the power chair user, who is capable of making such a decision, and his/her healthcare professional (i.e., medical doctor, physical therapist, etc.).

The contents of this manual are based on the expectation that a mobility device expert has properly fitted the power chair to the user and has assisted the prescribing healthcare professional and/or the authorized Pride provider in the instruction process for the use of the product.

There are certain situations, including some medical conditions, where the power chair user will need to practice operating the power chair in the presence of a trained attendant. A trained attendant can be defined as a family member or care professional specially trained in assisting a power chair user in various daily living activities.

As you begin using your power chair during daily activities, you will probably encounter situations in which you will need some practice. Simply take your time and you will soon be in full and confident control as you maneuver through doorways, on and off of elevators, up and down ramps, and over moderate terrain.

Below are some precautions, tips, and other safety considerations that will help the user become accustomed to operating the power chair safely.

Modifications

Pride has designed and engineered your power chair to provide maximum mobility and utility. A wide range of accessories is available from your authorized Pride provider to further customize your power chair to better suit your needs and/or preferences. However, under no circumstances should you modify, add, remove, or disable any feature, part, or function of your power chair.



WARNING! Do not modify your power chair in any way not authorized by Pride. Unauthorized modifications may result in personal injury and/or damage to your power chair.

Pre-Ride Safety Check

Get to know the feel of your power chair and its capabilities. Pride recommends that you perform a safety check before each use to make sure your power chair operates smoothly and safely. See XI. "Care and Maintenance."

Perform the following inspections prior to using your power chair:

- Check for proper tire inflation. Maintain **30-35 psi** in each tire (if equipped with pneumatic tires).
- Check all electrical connections. Make sure they are tight and not corroded.
- Check all controller connections to the electronics tray. Make sure they are secured properly.
- Check the brakes. See XI. "Care and Maintenance."
- Check battery charge. See VII. "Batteries and Charging."

II. SAFETY

NOTE: If you discover a problem, contact your authorized Pride provider for assistance.

Weight Limitations

Your power chair is rated for a maximum weight capacity. Please refer to the specifications table for this limit.



WARNING! Exceeding the weight capacity voids your warranty and may result in personal injury and/or damage to your power chair. Pride will not be held responsible for injuries and/or property damage resulting from failure to observe weight limitations.

WARNING! Do not carry passengers on your power chair. Carrying passengers on your power chair may result in personal injury and/or property damage.

Tire Inflation

If your power chair is equipped with pneumatic tires, you should check or have the air pressure checked at least once a week. Proper inflation pressures will prolong the life of your tires and help ensure the smooth operation of your power chair.



WARNING! It is important that 30-35 psi tire pressure be maintained in pneumatic tires at all times. Do not underinflate or overinflate your tires. Low pressure may result in loss of control, and overinflated tires may burst. Failure to maintain 30-35 psi tire pressure in pneumatic tires at all times may result in tire and/or wheel failure, causing serious personal injury and/or damage to your Jazzy.

WARNING! Inflate your power chair drive tires from a regulated air source with an available pressure gauge. Inflating your tires from an unregulated air source could overinflate them, resulting in a burst tire and/or personal injury.

Incline Information

More and more buildings have ramps with specified degrees of inclination, designed for easy and safe access. Some ramps may have turning switchbacks (180-degree turns) that require you to have good cornering skills on your power chair.

- Proceed with extreme caution as you approach the downgrade of a ramp or other incline.
- Take wide swings with your power chair's front wheels around any tight corners. If you do that, the power chair's rear wheels will follow a wide arc, not cut the corner short, and not bump into or get hung up on any railing corners.
- When driving down a ramp, keep the power chair's speed adjustment set to the slowest speed setting to ensure a safely controlled descent. See VIII. "Operation."
- Avoid sudden stops and starts.

When climbing an incline, try to keep your power chair moving. If you must stop, start up again slowly and then accelerate cautiously. When driving down an incline, set your power chair to the slowest setting and drive in the forward direction only. If your power chair starts to move down the incline faster than you anticipated or desired, allow it to come to a complete stop by releasing the joystick, then push the joystick forward slightly to ensure a safely controlled descent.

II. SAFETY

WARNING! When climbing an incline, do not zigzag or drive at an angle up the face of the incline. Drive your power chair straight up the incline. This greatly reduces the possibility of a tip or a fall. Always exercise extreme caution when negotiating an incline.



WARNING! You should not travel up or down a potentially hazardous incline (i.e., areas covered with snow, ice, cut grass, or wet leaves).

WARNING! When on any sort of an incline or decline, never place the power chair in freewheel mode while seated on it or standing next to it. Doing so may result in personal injury and/or damage to your power chair.

WARNING! Never travel down an incline backwards. This may result in personal injury.

WARNING! Even though your power chair is capable of climbing slopes greater than those illustrated in figure 1, do not, under any circumstances, exceed the incline guidelines or any other specifications presented in this manual. Doing so could cause instability in your power chair, resulting in personal injury and/or damage to your power chair.

In compliance with the Americans with Disabilities Act of 1990, all handicap public access ramps are required to have a maximum slope of 5°. Therefore, Pride recommends that the maximum slope of an incline you attempt to safely ascend or descend on your power chair does not exceed 5°. See figure 1.



WARNING! Any attempt to climb or descend a slope steeper than 5° may put your power chair in an unstable position and cause it to tip, resulting in personal injury.

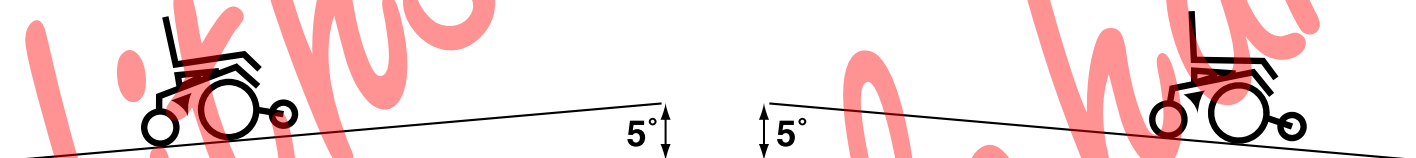

Figure 1. Maximum Safe Angle (Ascending and Descending)

Braking Information

Your power chair is equipped with two powerful brake systems:

1. Regenerative — uses electricity to rapidly slow the vehicle when the joystick returns to the center/stop position.
2. Disc Park Brake — activates mechanically after regenerative braking slows the vehicle to near stop, or when power is removed from the system for any reason.

Cornering Information

While your power chair is equipped with rear caster wheels in back and anti-tip wheels in front, excessively high cornering speeds can still create the possibility of tipping. Factors which affect the possibility of tipping include, but are not limited to: cornering speed, steering angle (how sharply you are turning), uneven road surfaces, inclined road surfaces, riding from an area of low traction to an area of high traction (such as passing from a grassy area to a paved area — especially at high speed while turning), and abrupt directional changes. High cornering speeds are not recommended. If you feel that you may tip over in a corner, reduce your speed and steering angle (i.e., lessen the sharpness of the turn) to prevent your power chair from tipping.



WARNING! When cornering sharply, reduce your speed. This greatly reduces the possibility of a tip or fall. To avoid personal injury and/or property damage, always exercise common sense when cornering.

II. SAFETY

Outdoor Driving Surfaces

Your power chair is designed to provide optimum stability under normal driving conditions—dry, level surfaces composed of concrete, blacktop, or asphalt. However, Pride recognizes that there will be times when you will encounter other surface types. For this reason, your power chair is designed to perform admirably on packed soil, grass, and gravel. Feel free to use your power chair safely on lawns and in park areas.

- Reduce your power chair's speed when driving on uneven terrain and/or soft surfaces.
- Avoid tall grass that can entangle the running gear.
- Avoid loosely packed gravel and sand.
- If you feel unsure about a driving surface, avoid that surface.

Freewheel Mode

Your power chair is equipped with a manual freewheel lever to allow for manual maneuverability by a trained attendant. For more information about how to place your power chair into and out of freewheel mode, see IV. "The Jet 3."

WARNING! Do not use your power chair in freewheel mode without an attendant present. Personal injury may result.



WARNING! Do not attempt to personally place your power chair in freewheel mode while seated on it. Personal injury may result. Ask an attendant for assistance if necessary.

WARNING! Do not place your power chair in freewheel mode while on an incline. The chair could roll uncontrollably on its own, causing personal injury.

Stationary Obstacles (Steps, Curbs, etc.)

Proceed with extreme caution when driving near raised surfaces, unprotected ledges and/or drop-offs (curbs, porches, stairs, etc.). The correct method for approaching a curb is illustrated in figure 2.



WARNING! Do not attempt to have your power chair climb or descend an obstacle that is higher than two inches unless you have the assistance of an attendant.

WARNING! Do not attempt to have your power chair proceed backward down any step, curb, or other obstacle. This may cause the power chair to tip and cause personal injury.

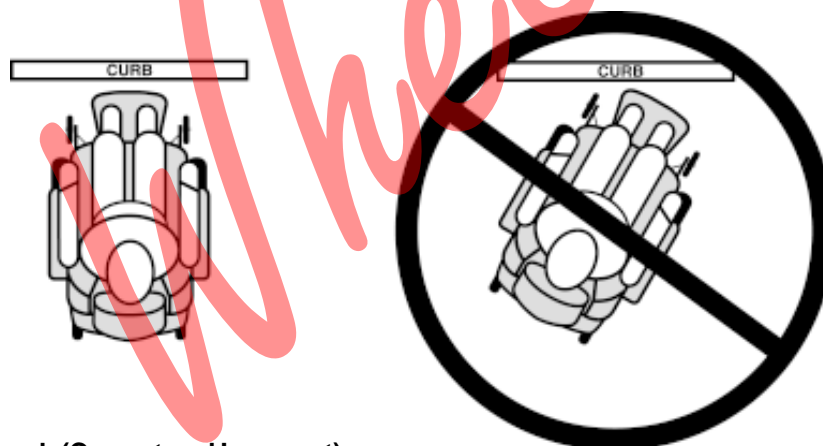

Figure 2. Curb Approach (Correct and Incorrect)

II. SAFETY

Public Streets and Roadways



WARNING! You should not operate your power chair on public streets and roadways. Be aware that it may be difficult for traffic to see you when you are seated on your power chair. Obey all local pedestrian traffic rules. Wait until your path is clear of traffic, and then proceed with extreme caution.

Stairs and Escalators

Power chairs are not designed to travel up or down stairs or escalators. Always use an elevator.



WARNING! Never use your power chair to negotiate steps or escalators. You may cause injury to yourself and to others and/or damage your power chair.

Doors

- Determine if the door opens toward or away from you.
- Drive your power chair gently and slowly forward to push the door open. Or drive your power chair gently and slowly backward to pull the door open.

Elevators

Modern elevators have a door edge safety mechanism that, when pushed, reopens the elevator door(s).

- If you are in the doorway of an elevator when the door(s) begin to close, push on the rubber door edge or allow the rubber door edge to contact the power chair and the door will reopen.
- Use care that pocketbooks, packages, or power chair accessories do not become caught in elevator doors.

EMI & RFI

Laboratory tests performed by the Food and Drug Administration (FDA) have shown that radio waves can cause unintended motion of electric mobility vehicles. Radio waves are a form of electromagnetic energy (EM). When EM adversely affects the operation of an electronic device, it is called Electromagnetic Interference (EMI) or Radio Frequency Interference (RFI). For more information, see III. "EMI/RFI."

Lift/Elevation Products

If you will be traveling with your power chair, you may find it necessary to use a lift/elevation product to aid in transportation. Pride recommends that you closely review the instructions, specifications, and safety information set forth by the manufacturer of the lift/elevation product before using that product.

Motor Vehicle Transport

Currently, there are no standards approved for tie-down systems in a moving vehicle of any type to transport a person while seated in a power chair.

Transfers

Transferring onto and off of your power chair requires a good sense of balance. Always have an attendant or healthcare professional present while learning to properly transfer yourself.

II. SAFETY

To eliminate the possibility of injury, Pride recommends that you or a trained attendant perform the following tasks before attempting a transfer:

- Turn the power off. See VIII. "Operation."
- Ensure your power chair is not in freewheel mode. See IV. "The Jet 3."
- Turn both caster wheels toward the transfer destination to improve power chair stability during transfer.
- Make sure both armrests are flipped up or removed from your power chair.
- Flip the footrest up, or move the leg rests aside; this will help to keep your feet from getting caught on the footrest or the leg rests during the transfer.
- Reduce the distance between your power chair and the object you are transferring onto.

WARNING! Before transferring, position yourself as far back as possible in the power chair seat to prevent the power chair from tipping forward during transfer and causing injury.



WARNING! Avoid using your armrests for weight bearing purposes. Such use may cause the power chair to tip and cause personal injury.

WARNING! Avoid putting all of your weight on the footrest. Such use may cause the power chair to tip and cause personal injury.

Positioning Belts

Your authorized Pride provider, therapist(s), and other healthcare professionals are responsible for determining your requirement for a positioning belt in order to operate your power chair safely.

WARNING! If you require a positioning belt to safely operate your power chair, make sure it is fastened securely. Serious personal injury may result if you fall from the power chair.



WARNING! The positioning belt is not designed for use as a seat belt in a motor vehicle. Nor is your Jazzy suitable for use as a seat in any vehicle. Anyone traveling in a vehicle should be properly belted into seats approved by the vehicle manufacturer.

WARNING! Do not sit on your power chair while it is in a moving vehicle. Personal injury and/or property damage may result.

WARNING! Always be sure your power chair and its batteries are properly secured when it is being transported. Failure to do so may result in personal injury and/or damage to your power chair.

II. SAFETY

Inclement Weather Precautions



WARNING! Pride recommends that you do not operate your power chair in icy or slippery conditions or on salted surfaces (i.e., walks or roads). Such use may adversely affect the performance and safety of your power chair, resulting in an accident and personal injury.

WARNING! Do not expose your power chair to any type of moisture at any time (rain, snow, mist, or wash). Such exposure can damage your power chair. Never operate your power chair if it has been exposed to moisture until it has dried thoroughly.

Reaching and Bending

Never reach, lean, or bend while driving your power chair. If it is absolutely necessary to reach, lean, or bend while seated on your power chair, it is important to maintain a stable center of gravity and keep the power chair from tipping. Pride recommends that the power chair user determine his/her personal limitations and practice bending and reaching in the presence of a qualified healthcare professional.



WARNING! Do not bend, lean, or reach for objects if you have to pick them up from the floor by reaching down between your knees. Movements such as these may change your center of gravity and the weight distribution of the power chair. This may cause your power chair to tip, possibly resulting in personal injury. Keep your hands away from the tires when driving.

Batteries

In addition to following the warnings below, be sure to comply with all other battery handling information. For more information about your power chair's batteries, see VII. "Batteries and Charging."



WARNING! Power chair batteries are heavy. See specifications table. If you are unable to lift that much weight, be sure to get help. Lifting beyond your capacity can result in personal injury.

WARNING! Battery posts, terminals, and related accessories contain lead and lead compounds. Wash hands after handling.

WARNING! Always protect the batteries from freezing and never charge a frozen battery. Charging a frozen battery may result in personal injury and/or damage to the battery.

Preventing Unintended movement



WARNING! If you anticipate being seated in a stationary position for an extended period of time, turn off the power. This will prevent unexpected motion from inadvertent joystick contact. This will also eliminate the possibility of unintended chair movement from electromagnetic (EM) sources. Failure to do so may result in personal injury.

II. SAFETY

Prescription Drugs/Physical Limitations

Users must exercise care and common sense when operating a power chair. This includes awareness of safety issues when taking prescribed or over-the-counter drugs or when the user has specific physical limitations.



WARNING! Consult your physician if you are taking prescribed or over-the-counter medication or if you have certain physical limitations. Some medications and limitations may impair your ability to operate your power chair in a safe manner.

Alcohol

The power chair user must exercise care and common sense when operating his/her power chair. This includes awareness of safety issues while under the influence of alcohol.



WARNING! Do not operate your power chair while you are under the influence of alcohol, as this may impair your ability to operate your power chair in a safe manner.

Removable Parts



WARNING! Do not attempt to lift or move a power chair by any of its removable parts. Personal injury and/or damage to the power chair may result.

III. EMI/RFI

Laboratory tests performed by the Food and Drug Administration (FDA) have shown that radio waves can cause unintended motion of power chairs. Radio waves are a form of electromagnetic energy (EM). When this energy unintentionally affects the operation of an electronic device, it is called *Electromagnetic Interference (EMI)* or *Radio Frequency Interference (RFI)*.



WARNING! Radio waves may interfere with the control of power chairs.

FREQUENTLY ASKED QUESTIONS (FAQS)

The following FAQs summarize what you should know about EMI/RFI. Use this information to minimize the risk that EMI/RFI may affect your power chair.

Where do radio waves come from?

Radio waves are emitted from the antennas of cellular phones, mobile two-way radios (such as walkie-talkies), radio stations, TV stations, amateur radio (HAM) transmitters, wireless computer links, microwave sources, and paging transmitters. Radio waves are a form of EMI. Because EMI is more intense closer to the transmitting antenna (source of emission), the EMI fields from two-way radios are of special concern.

If my power chair is affected by EMI/RFI, what kind of motion should I expect?

This is hard to predict. The effect may depend on a number of factors including:

- Strength of the radio waves
- Construction of the power chair
- Position of the power chair (whether it is on level ground or on a slope)
- Whether or not the power chair is in motion

An affected power chair's movement can be erratic. The chair may move by itself or come to a sudden stop. Furthermore, it is possible for EMI/RFI to unexpectedly release the brakes on a power chair. Some intense sources of EMI/RFI can even damage the control system of your Jet 3.

Is there any way to know for sure whether radio waves are responsible for the unintended motion of my power chair?

Unfortunately, interference from radio wave sources may be difficult to recognize, because the signals from these sources are invisible and may be intermittent. However, the FDA recommends that you report all incidents of unintended motion or brake release to the power chair manufacturer and, if possible, note whether there was a radio wave source nearby at the time of the incident.

Has anyone been hurt from erratic, unintended motion of power chairs?

The FDA has reports of injuries that may have resulted from the uncontrolled motion of power chairs. However, it is unclear how many of these incidents were actually caused by radio wave interference.

Are all power chairs susceptible to EMI/RFI?

Each make and model differs in its ability to resist electromagnetic interference. That is, each has a particular level of immunity to interference, measured in volts per meter (V/m). A higher immunity level offers greater protection.

III. EMI/RFI

In other words, a power chair with a high immunity level is less likely to be affected by a strong radio source than one with a low immunity level.

What is the FDA doing about the problem?

The FDA has written to power chair manufacturers and requested that they test their new products to be sure that they provide a reasonable degree of immunity against EMI/RFI. The letter states that power chairs should have an immunity level of at least 20 V/m. This provides a reasonable degree of protection against the common sources of EMI/RFI.

The FDA has also requested that these manufacturers clearly label their products with the immunity level, or state that the immunity level is not known. The labeling and informational material supplied with the power chair must explain what the immunity level means, and the labeling or informational material must warn users about the possibility of EMI/RFI and how to avoid it. In addition, the FDA has recommended that manufacturers establish an educational program to inform power chair users, and their caregivers about the problems associated with EMI/RFI, and actions that they can take to minimize the risk. The FDA requested that power chair manufacturers implement these actions by December 2, 1994.

What can I do to find out if my power chair is likely to be affected by EMI/RFI?

If you've had your power chair for a long time and haven't experienced any unintended motion, it is not likely that you will have problems in the future. However, it is always possible that problems could arise if your power chair is close to a source of radio waves. Therefore, it is very important to be alert to this possibility. The Jet 3 meets or exceeds an immunity level of at least 20 V/m.

What can I do to reduce the risk that my power chair could be affected by EMI/RFI?

Here are some precautions you can take:

- Do not turn on or use hand-held personal communications devices, such as citizens band (CB) radios and cellular phones, while the power chair is on.
- Be aware of nearby transmitters such as radio or TV stations and hand-held or mobile two-way radios, and try not to come close to them. For example, if you are in a power chair with an immunity level of 20 V/m, you should remain at least three feet from a hand-held two-way radio and ten feet from a mobile two-way radio.
- Be aware that adding accessories and/or components or modifying the power chair may make it more susceptible to interference from radio wave sources.
- There is no easy way to evaluate the effect of accessories or modifications upon the overall immunity of the power chair.

What should I do if my power chair moves unexpectedly?

If unintended motion or brake release occurs, turn the power chair off as soon as it is safe to do so.

If my power chair moves unexpectedly, where should I report this?

Call Pride Mobility Products Corporation at 800-424-8205 to report the incident.

IV. THE JET 3

Your Jet 3 has two main assemblies: the seat and the power base. See figure 3. There are a variety of seating options that are designed to accommodate most users. Typically, the seating system includes armrests, seatback, and joystick/controller. Your Jet 3 seat may also have some optional accessories, such as a basket, a cane/crutch holder, a cup holder, and/or a power seat switch.

The power base is the heart of the Jet 3. The power base assembly includes two motor/brake assemblies, two anti-tip assemblies with anti-tip wheels, a caster assembly with two rear casters, two batteries, a power seat actuator (optional), and a connector housing. See figure 3 below and figures 4a and 4b.

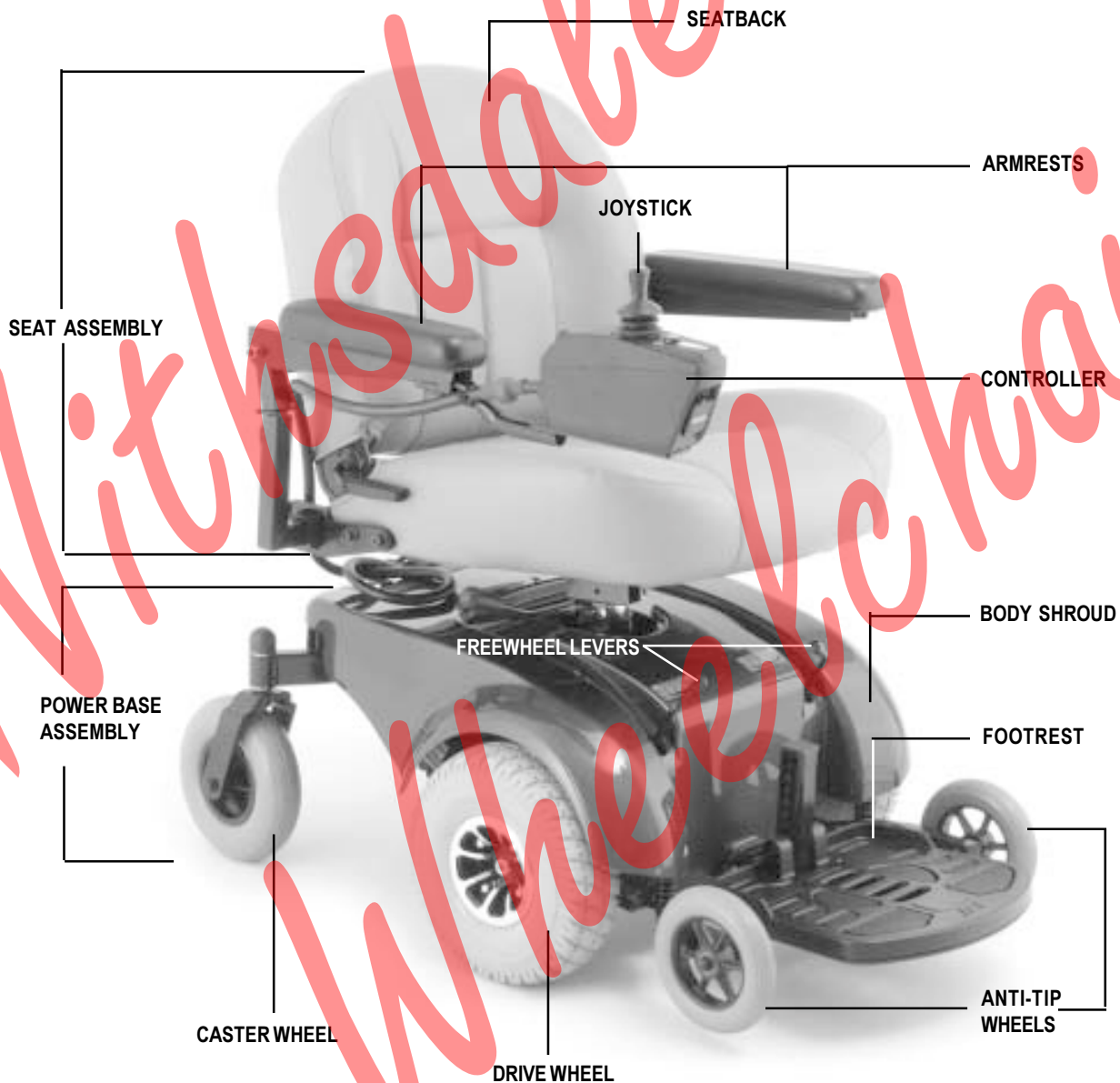

Figure 3. The Jet 3

IV. THE JET 3

SPECIFICATIONS	
Drive Wheels:	10-in. solid, center-mounted (solid tires are optional)
Caster Wheels:	8-in. solid, rear articulating
Anti-tip Wheels:	6-in. solid, front mounted
Maximum Speed:	Up to 4 mph
Brakes:	Electronic regenerative "Intelligent Braking," disc parking brake
Ground Clearance:	3 in.
Turning Radius:	18.5 in.
Overall Size:	Length: 34.5 in. Width: 23 in.
Seating Options:	Medium back (standard) High back, with headrest
Drivetrain:	Two-motor, mid-wheel
Batteries:	Two 12-volt, U-1 batteries
Range:	Up to 20 miles
Battery Charger:	4-amp, onboard (standard) 4-amp, off-board
Electronics:	Pilot Controller VSI Controller (standard)
Weight Capacity:	250 lbs.
Component Weights:	Base: 95 lbs. Seat: 36.5 lbs. Batteries: 24.5 lbs. each
Warranties:	Five-year limited warranty on frame One-year warranty on electronics One-year warranty on drive motors

IV. THE JET 3

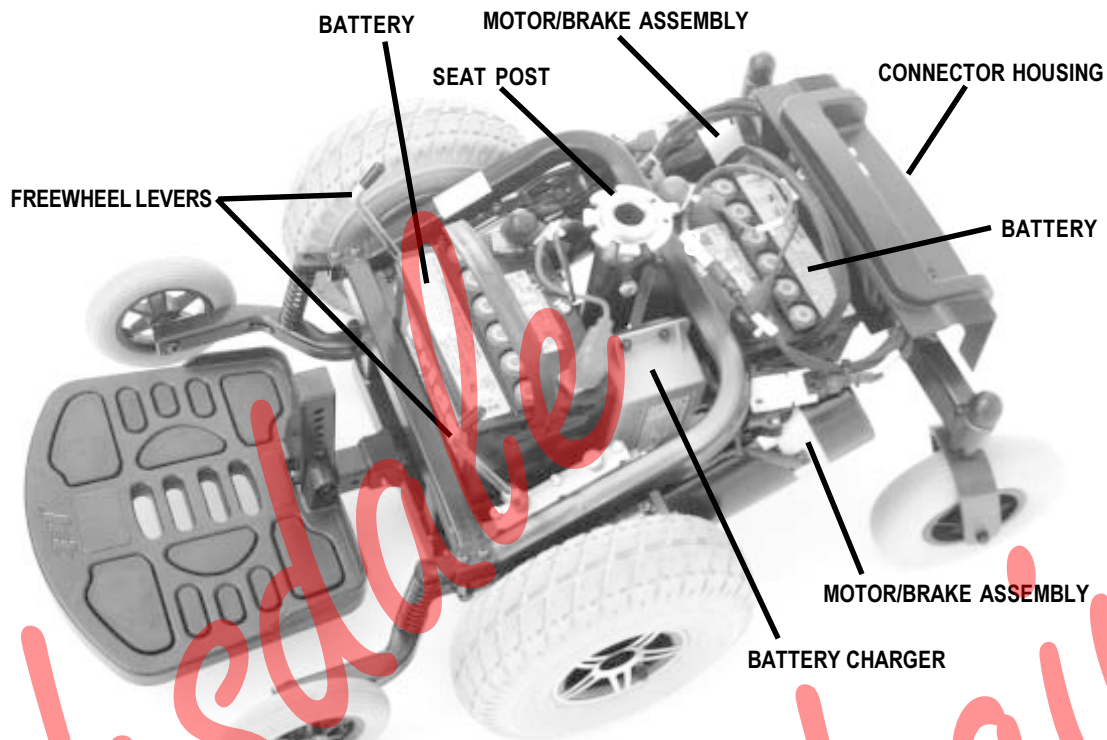

Figure 4a. Jet 3 Power Base (Shroud Removed)

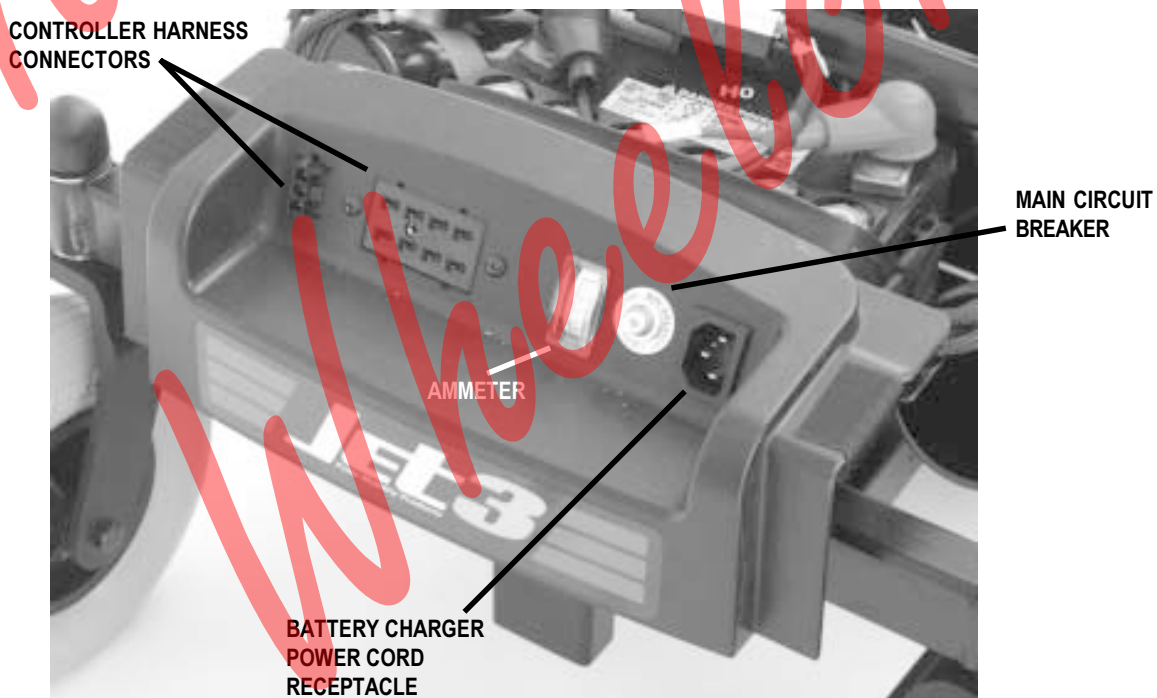

Figure 4b. Electronics Connector Housing

IV. THE JET 3

ELECTRONICS CONNECTOR HOUSING

The connector housing is located on the rear of the Jet 3. See figures 4a and 4b. The connector housing holds the ammeter, the battery charger power cord receptacle, the main circuit breaker, and controller harness connectors.

Ammeter: The ammeter displays the charger's current output in amps. For more information, see VII. "Batteries and Charging."

Battery charger power cord receptacle: This is for your battery charger power cord. The cord is typically located in the seat pocket. For more information, see VII. "Batteries and Charging."

Main circuit breaker: The main circuit breaker is a safety feature built into your Jet 3. When the batteries and the motors are heavily strained (e.g., from excessive loads), the main circuit breaker will trip to prevent damage to the motors and the electronics. If the circuit breaker trips, allow the Jet 3 to "rest" for approximately one minute. Then, push in the circuit breaker button, turn on the controller power, and continue normal operation. If the main circuit breaker continues to trip repeatedly, contact your authorized Pride provider.

Controller harness connectors: These connect the controller cables to the power base.

POSITIONING BELT

The following positioning belt is available as an option from your authorized Pride provider. It is designed to support the operator's torso so that he or she does not slide downward or forward in the seat. See figure 5. Your equipment may vary.

- The positioning belt is not designed for use as a restraining device.
- Make sure the belt is secure but does not cause discomfort.



WARNING! The positioning belt is not designed for use as a seat belt in a motor vehicle. Nor is your Jet 3 suitable for use as a seat in any vehicle. Anyone traveling in a vehicle should be properly belted into seats approved by the vehicle manufacturer.



Figure 5. Positioning Belt

IV. THE JET 3

FREEWHEEL LEVERS

For convenience, your Jet 3 is equipped with two freewheel levers. See figure 4a. These levers allow you to disengage the drive motors and maneuver the chair manually.

To engage or disengage the drive motors:

1. Locate the two (2) metal levers protruding through the body shroud.
2. Turn the levers outward to engage the drive motors. See figure 6.
3. Turn the levers inward to disengage the drive motors (freewheel mode). See figure 7.

If a lever is difficult to move in either direction, rock the Jet 3 gently back and forth while turning the levers. The lever should then move to the desired position.



WARNING! Do not use your Jet while the drive motors are disengaged unless you are in the presence of an attendant! Do not disengage the drive motors when your Jet is on an incline. The chair could roll down on its own, causing injury!



CAUTION! It is important to remember that when your Jet is in freewheel mode, the braking system is disengaged.



Figure 6. Drive Motors Engaged



Figure 7. Drive Motors Disengaged (Freewheel Mode)

V. COMFORT ADJUSTMENTS

After you have used your Jet 3 for an extended period of time, you may find the need to make some adjustments increase your comfort.



CAUTION! If your Jet was configured at your authorized Pride provider, please consult your healthcare professional before changing the seat position or making any other adjustment. Some adjustments may degrade your Jet's performance and safety by changing its center of gravity.

SEAT HEIGHT

You can change the seat height to one of five positions in one-inch increments.

To change the seat height:

1. Remove the seat. See VI. "Disassembly."
2. Remove the shroud.
3. Use a 14 mm wrench to loosen and remove the hex-head nut and bolt. See figure 8.
4. Loosen the seat post base locking nut using a 11 mm wrench and a 5 mm hex key.
5. Slide the seat pedestal up or down in the seat post base.
6. Align the holes on the seat post and the seat post base.
7. Reinstall and tighten the hex-head nut and bolt.
8. Retighten the seat post base locking nut.



Figure 8. Seat Height Adjustment

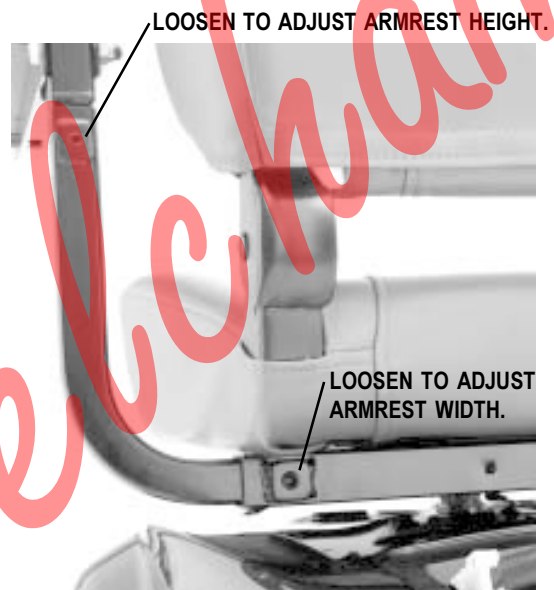

Figure 9. Armrest Width and Height Adjustment

ARMREST WIDTH AND HEIGHT

To change the armrest width:

1. Locate the setscrew on the armrest receiver bracket. See figure 9.
2. Loosen the setscrew, and slide the armrest in or out to the desired width.
3. Retighten the setscrew.
4. Repeat for the other armrest.

V. COMFORT ADJUSTMENTS

To change the armrest height:

1. Loosen the armrest adjustment height setscrew located underneath the armrest. See figure 9.
2. Raise or lower the armrest as desired.
3. Retighten the setscrew.
4. Repeat for the other armrest.

ARMREST ANGLE

You can adjust the armrest angle to fit your specific needs.

To change the armrest angle:

1. Lift the armrest straight up so that it is perpendicular to the floor.
2. Use an 11 mm wrench to loosen the bolt. See figure 10.
3. Use a 11 mm wrench to loosen the bolt. Turn the screw clockwise to raise the front of the armrest and counterclockwise to lower the front of the armrest.
4. Lock the adjusting screw into place by tightening the jam nut.

JOYSTICK EXTENSION

The joystick control can easily slide out away from the armrest, or in toward the armrest.

To extend the joystick:

1. Use a 5 mm hex key to loosen the setscrew. See figure 11.
2. Slide the joystick mounting bracket into or out of the armrest to the desired position.
3. Retighten the setscrew by turning it clockwise.

JOYSTICK POSITION

You can position the joystick for either left-hand or right-hand use.

To change the joystick position:

1. Disconnect the controller harness connectors. See figure 5.
2. Cut the wire tie that attaches the controller cable to the armrest. See figure 12.
3. Use a 5 mm hex key to loosen the setscrew. See figure 11.
4. Slide the joystick mounting out of the armrest.
5. Loosen the setscrew in the other armrest.
6. Place the joystick bracket in the other armrest.
7. Tighten the setscrew in each armrest.
8. Connect the controller cable to the armrest with a new wire tie. See figure 12.

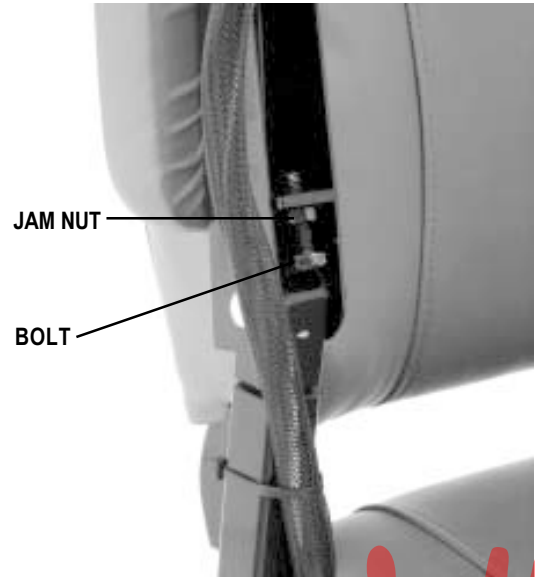

Figure 10. Armrest Angle



Figure 11. Joystick Extension

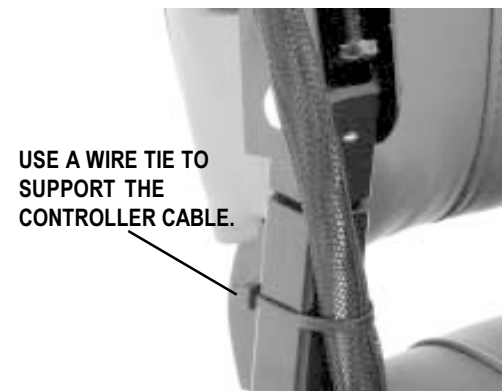

Figure 12. Wire Tie Location

V. COMFORT ADJUSTMENTS



CAUTION! Do not place the controller cable so that it can be pinched in the seat frame or the power base frame.

FOOTREST ANGLE

You can adjust the angle of the footrest with a 5 mm hex wrench. See figure 13.

To adjust the foot rest angle:

1. Turn the setscrew clockwise to lower the front of the footrest.
2. Turn the setscrew counterclockwise to raise the front of the footrest.

FOOTREST HEIGHT

The footrest height is easily adjusted to any one of six different heights. See figure 14.

To raise or lower the footrest:

1. Remove the bolt from the footrest using a 6 mm hex key and 13 mm socket.
2. Raise or lower the footrest to the desired height. See figure 14.
3. Reinstall the bolt into the footrest.

FOOTREST DEPTH

The Jet 3 uses a ball detent pin to fasten footrest to the power base. See figure 14.

To adjust the footrest depth:

1. Remove the ball detent pin from the footrest bracket.
2. Move the footrest in or out to the desired depth.
3. Reinstall the ball detent pin.

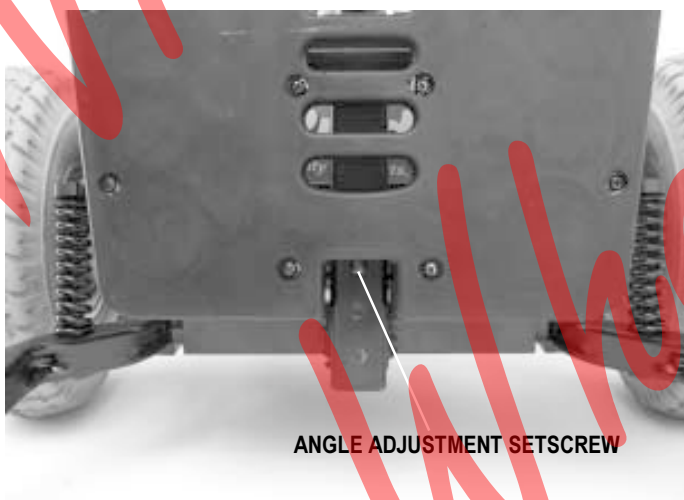

Figure 13. Footrest Angle Adjustment

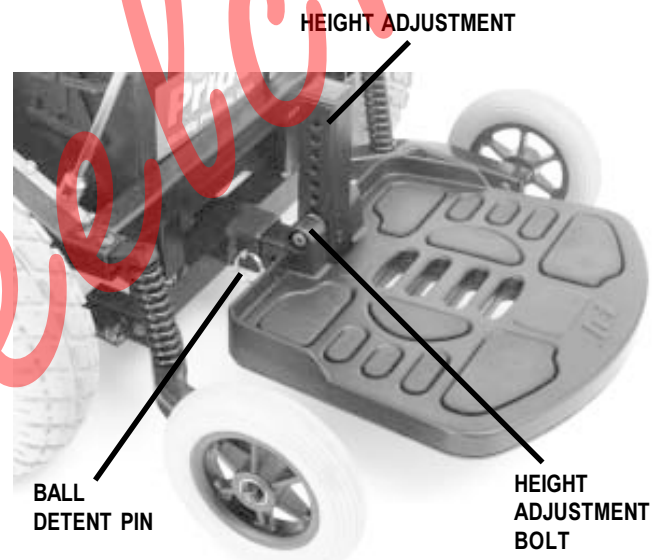

Figure 14. Footrest Depth and Height Adjustment

V. COMFORT ADJUSTMENTS

ANTI-TIP WHEELS

The Jet 3 mid-wheel drive design provides superior performance and safety. The anti-tip wheels are an integral part of this design, because they provide stability during deceleration. The anti-tip wheels are preset at the factory to a height of 1/2-in. off the ground. This is the ideal setting for most Jet 3 users. However, you may encounter situations where you may need to adjust the anti-tip wheels. For instance, if you drive your Jet 3 on deep-pile carpeting or similar surfaces, you may notice that the anti-tip wheels have a tendency to drag on the carpet. In this case, you may need to raise the anti-tip wheels. If you drive your Jet 3 primarily on smooth surfaces, such as linoleum or tile, you may find that you are tipping forward a bit more than you find comfortable. (This may be particularly true for lighter users.) In this case, you may need to lower the anti-tip wheels.

WARNING! Consult your authorized Pride provider before attempting to change the anti-tip wheel height! Changing the anti-tip wheel height affects handling under deceleration!



WARNING! The higher you raise the anti-tip wheels, the more you increase your power chair's tendency to tilt forward when coming to a stop. You can compensate for this by having your authorized Pride provider make a small adjustment to the pre-programmed deceleration setting in the controller or by moving the seat assembly further to the rear of your power chair.

Required Tools: 13 mm wrench.

To adjust the anti-tip wheel height:

1. Remove the seat, the body shroud, and the batteries. See VI. "Disassembly" and VII. "Batteries and Charging."
2. Locate the jam nut and bolt on the anti-tip assembly. See figure 15.
3. Use a 13 mm wrench to loosen the jam nut.
4. Turn the bolt clockwise to raise the anti-tip wheel. Turn the bolt counterclockwise to lower the anti-tip wheel.
5. Tighten the jam nut.
6. Repeat for other anti-tip wheel.

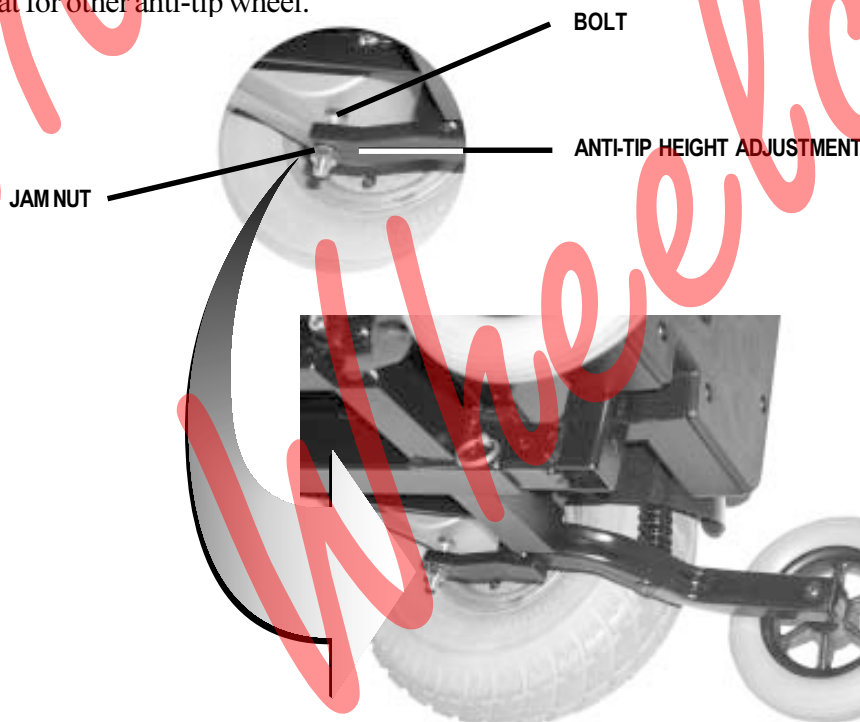

Figure 15. Anti-tip Height Adjustment

VI. DISASSEMBLY

SEAT REMOVAL

You may wish to remove the seat to transport your Jet 3.



WARNING! Do not pick up the seat frame by the armrests. They are free to pivot, and you may lose control of the seat if they do so, resulting in personal injury or damage to the chair.

To remove the seat:

1. Turn the power off.
2. Make sure the Jet 3 is not in freewheel mode.
3. Unplug the main wiring harness behind the seat.
4. Lift the seat up and out of the seat tower.

BODY SHROUD REMOVAL

The body shroud is a one-piece molded plastic body that covers the power base frame. You must remove the body shroud in order to change the batteries and check the cable connections.

To remove the body shroud:

1. Turn the power off.
2. Make sure the Jet 3's motors are engaged. See IV. "The Jet 3."
3. Unplug the controller wiring harness.
4. Pull lever and turn the seat slightly while lifting.
5. Remove the seat.
6. Lift the body shroud straight up. It should lift up easily.

BATTERY REMOVAL

To remove the batteries, see VII. "Batteries and Charging."

VII. BATTERIES AND CHARGING

Your Jet 3 uses two long-lasting, 12-volt, deep-cycle batteries that are sealed and maintenance-free. Since they are sealed, there is no need to check the electrolyte (fluid) level. Deep-cycle batteries are designed to handle a deep discharge. Though they are similar in appearance to automotive batteries, they are not interchangeable. Automotive batteries are not designed to handle a long, deep discharge and also are unsafe for use in power chairs.



WARNING! Battery posts, terminals, and related accessories contain lead and lead compounds. Wash hands after handling.

CHARGING YOUR BATTERIES

The battery charger is one of the most important parts of your Jet 3. The battery charger is designed to optimize your Jet 3's performance by charging the batteries quickly and easily. The charging system consists of the charger, a charger fuse, and the ammeter. The onboard charger is located between the batteries. See figure 16. The ammeter is located on the electronics connector housing, for easy viewing. The 7.5 amp, in-line fuse is located under the electronics connector housing. The in-line fuse protects the entire charger circuit from shorts or bad connections. The ammeter indicates the rate of charge necessary to fully recharge the batteries. The ammeter is also a good indication of whether or not the charger is working. The ammeter and the charger are functional only when the charger power cord is plugged into a wall outlet.

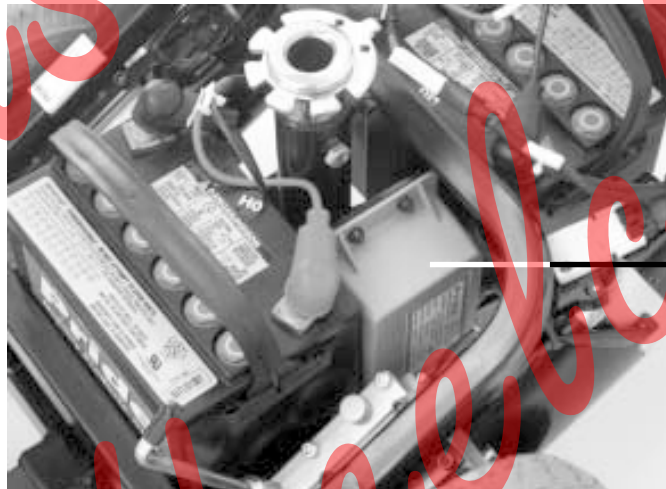

ONBOARD CHARGER

Figure 16. Charger



WARNING! You must recharge your Jet 3's batteries with the supplied onboard or external charging system. Do not use an automotive-type battery charger.

WARNING! Never use an extension cord to plug in your battery charger. Plug the charger directly into a properly wired standard wall outlet.

WARNING! Always protect batteries from freezing temperatures and never charge a frozen battery. This damages the battery and may cause personal injury. Attempting to charge a battery in freezing conditions does not prevent a battery from freezing.

VII. BATTERIES AND CHARGING

To charge the batteries using the onboard charger:

1. Position the rear of your Jet 3 close to a standard wall outlet.
2. Be certain the controller power is turned off and the Jet 3 is not in freewheel mode.
3. Plug the charger cord into the receptacle on the connector housing.
4. Extend the charger power cord and plug it into the wall outlet. The Jet 3 incorporates an inhibit function that disables the power chair when the charger is plugged into a wall outlet.
5. The ammeter will indicate how much charge is needed to fully charge the batteries. Wait about a minute for the charger to warm up. The ammeter may move up to as high as 4 amps, then gradually move back down to 0 amps as it charges.
6. We recommend you charge the batteries for 8 to 14 hours. As the batteries charge, the ammeter needle will slowly drop to the zero mark. When the batteries are fully charged, the needle will vibrate on or about the zero mark on the meter scale.
7. When your Jet 3 batteries are fully charged, unplug the power cord from the wall outlet and from the charger receptacle and store the cord in a safe place.

EXTERNAL CHARGER

Your Jet 3 may be equipped with an external charger. Typically, external chargers plug into the joystick controller. If your Jet 3 is equipped with an external charger, refer to the instructions that come with the charger.

BATTERY BREAK-IN

To break in your Jet 3's new batteries for maximum efficiency:

1. Fully recharge any new battery prior to its initial use. This will bring the battery up to about 90% of its peak performance.
2. Run your Jet 3 about the house. Move slowly at first and don't stray too far until you grow accustomed to the controls and break-in the batteries.
3. Give the batteries another full charge of 8 to 14 hours and run the Jet 3 again. The batteries will now perform at over 90% of their potential.
4. After four or five charging cycles, the batteries will top off at 100% charge and last for an extended period.

How does the charger work?

The battery charger takes the standard wall outlet voltage (alternating current) and converts it to VDC (direct current). The Jet 3 batteries use direct current to run your power chair. When the battery voltage is low, the charger works harder to charge the batteries. This is why the charging ammeter initially reads 3.5 or more amps. As the battery voltage approaches full a charge, the charger doesn't work as hard to complete the charging cycle. This explains why the charging ammeter drops as it approaches a full charge. When the batteries are fully charged, the amperage from the charger is almost at zero. This is how the charger maintains a charge but does not overcharge the battery. Your Jet 3's charger will not operate after the batteries have been discharged to nearly zero voltage. If this happens, call your authorized Pride provider for assistance.

Can I use a different battery charger?

You should use the charger supplied with the Jet 3. It is the safest, most efficient way to charge the batteries. We do not recommend using other types of chargers (e.g., an automotive battery charger).

VII. BATTERIES AND CHARGING

How often must I charge the batteries?

Many factors come into play when deciding how often to charge the batteries. You may use your Jet 3 all day on a daily basis or you may not use it for weeks at a time.

DAILY USE

If you use your Jet 3 on a daily basis, charge the batteries as soon as you are finished using it for the day. Each morning your Jet 3 will be ready to give you a full day's service. We recommend that you charge the batteries for 8 to 14 hours after daily use. Do not charge the batteries for more than 24 hours.

INFREQUENT USE

If you use your Jet 3 infrequently (once a week or less), you should charge the batteries at least once per week for 12 to 14 hours.

NOTE: Keep the batteries fully charged and avoid deeply discharging the batteries. Do not charge them for more than 24 hours, at one charge.

How can I get maximum range or distance per charge?

Rarely will you have an ideal driving situation, such as smooth, flat, hard terrain with no hills or curves. More often, you will be presented with hills, sidewalk cracks, uneven and loosely packed surfaces, and curves. All of these factors will affect the distance or running time per battery charge. Below are a few suggestions for obtaining the maximum range per charge:

- Always fully charge the batteries prior to your trip.
- Maintain **30 - 35 psi** in pneumatic drive wheels.
- Plan your trip in advance to avoid inclines if possible.
- Limit the baggage weight to essential items.

What type of battery should I use?

We recommend deep-cycle batteries that are sealed and maintenance free. Both AGM and Gel-Cell are deep-cycle batteries and are similar in performance.

Use these specifications to reorder deep-cycle batteries:

Battery Type	
Type:	Deep-cycle AGM or Gel-Cell
Size:	U-1
Voltage:	12 V each
Amp Hours:	30–35 amp hours



WARNING! Corrosive chemicals contained in batteries. Use only AGM or Gel-Cell batteries to reduce the risk of leakage or explosive conditions.

VII. BATTERIES AND CHARGING

Why do my new batteries seem weak?

Deep-cycle batteries employ a different chemical technology than that used in car batteries, nickel-cadmium (nicads), or in other common battery types. Deep-cycle batteries are specifically designed to provide power, drain down, and then accept a relatively quick recharge. Lead-acid batteries should be charged as often as possible. They do not have a “memory” like nickel-cadmium batteries.

We work closely with our battery manufacturer to provide batteries that best suit the Jet 3’s specific demands. Fresh batteries arrive regularly and are promptly shipped with a full charge. During shipping, the batteries encounter temperature extremes that may influence their initial performance. Heat will rob the charge from the battery, and cold will slow the power available and extend the time needed to recharge the battery (just as with a car battery). It may take a few days for the temperature of a battery to stabilize and adjust to its new ambient temperature. More importantly, it will take a few “charging cycles” (partial drains followed by full recharging) to establish the critical chemical balance that is essential to a battery’s peak performance and long life.

It will be well worth it for you to take the time to break-in the batteries properly.

NOTE: The useful life of a battery is quite often a reflection of the care it receives.

How can I ensure maximum battery life?

A fully charged deep-cycle battery will provide reliable performance and extended life. So, keep the batteries fully charged whenever possible. Batteries that are regularly and deeply discharged, infrequently charged, or stored without a full charge may be permanently damaged, causing unreliable Jet 3 operation and limited battery life.

How should I store my Jet 3 and batteries?

If you do not use your Jet 3 regularly, we recommend maintaining battery power by charging the batteries at least once per week.

If you do not plan on using your Jet 3 for an extended period of time, fully charge the batteries prior to storage. Disconnect the battery harnesses and store the Jet 3 in a warm, dry environment. Avoid temperature extremes, such as freezing or excessively hot conditions, and never attempt to charge a frozen battery. A cold or frozen battery should be warmed for several days prior to recharging.

NOTE: If you are storing a Jet 3 for an extended period of time, you may wish to block the unit up off the ground or floor with several boards placed under the frame. This will keep the tires off the ground and prevent the possibility of flat spots developing where the tires rest on the ground or floor.

What about public transportation?

Sealed lead-acid and gel cell batteries are designed for application in power chairs and other mobility vehicles. These batteries are Federal Aviation Administration (FAA) approved, allowing safe transportation on aircraft, buses, and trains, as there is no danger of spillage or leakage. We suggest you contact the commercial carrier’s ticket counter in advance to determine the carrier’s specific requirements.

If you wish to ship the Jet 3 to your final destination using a freight company, repack the Jet 3 in the original shipping container and ship your batteries in separate boxes. Use only sealed lead-acid or gel cell type batteries that are maintenance free. Do not use wet-cell batteries with removable caps.

VIII. OPERATION

VSI CONTROLLER

The electronic controller is what you use to operate your power chair. It takes the battery voltage and sends it to the appropriate system. The electronic controller enables you to move the power chair, as well as monitor battery charge, electronic controller functions, and the condition of your electrical system. Also, it may be used to control some optional systems such as power elevating seats and lights.

The VSI controller is an integral electronic controller. All of the electronics necessary to operate the power chair are contained in one module. See figure 17.

The VSI consists of:

1. joystick
2. keypad (see figure 18)
3. off-board charger/programming socket
4. actuator connector (optional)
5. controller connector
6. 3-pin charger inhibit connector

Typically, the VSI is mounted to one of the armrests and is connected to the motors, batteries, and the onboard charger at the electronics tray.

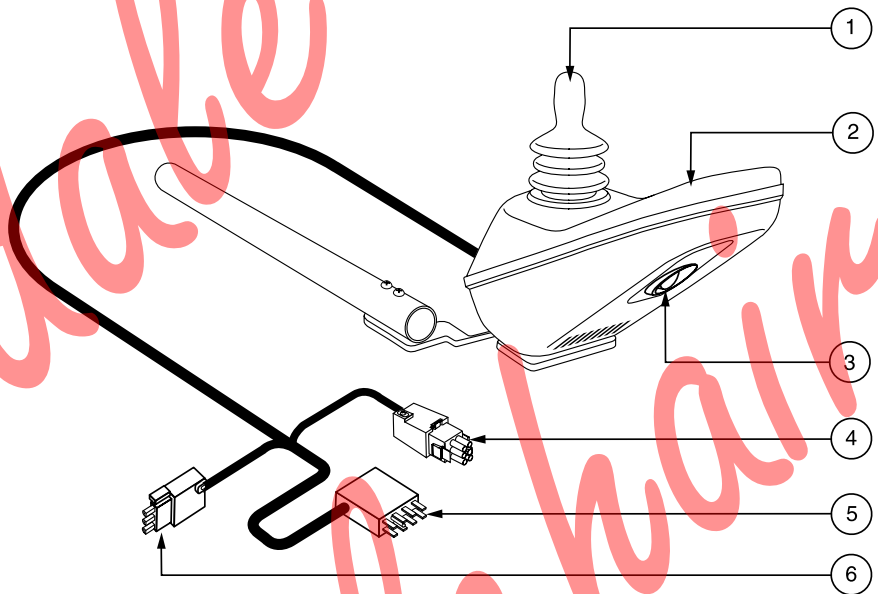

Figure 17. VSI Controller

Joystick

The joystick controls the direction and speed of your power chair. When you move the joystick from the neutral (center) position, the electromagnetic brakes release and allow your power chair to move. The further you push the joystick from its neutral position, the faster your power chair moves. When you release the joystick and allow it to return to the neutral position, you engage the electromagnetic brakes. This causes your power chair to decelerate and come to a complete stop.



WARNING! If your power chair begins to move in an unexpected manner, immediately release the joystick. Unless the joystick is damaged, this action should stop your power chair.

Keypad

The keypad is located in front of the joystick. It contains keys necessary to operate your Jazzy. See figure 18.

VIII. OPERATION

On/Off Key

The on/off key turns the VSI on and off.



WARNING! Unless faced with an emergency situation, do not use the on/off key to stop the chair. This will cause the power chair to stop abruptly.

WARNING! Always turn the power off when you are stationary to prevent unexpected movement.

Battery Condition Meter

The battery condition meter is located in front of the joystick. See figure 18. This is a 10-segment illuminated display that indicates that the VSI is turned on and also gives the battery status, the VSI status, and the electrical system status.

- **Red, yellow, and green lights lit:** Battery charged; VSI and electrical system OK.
- **Red and yellow lights lit:** Charge battery if possible; VSI and electrical system OK.
- **Red lights only lit or slow flash:** Charge battery as soon as possible; VSI and electrical system OK.
- **Rapid flash of lights:** Indicates a fault in the VSI or the electrical system. Refer to “VSI Error Codes.”
- **Ripple up and down of lights:** The joystick was not in the neutral position when the controller was turned on. If you get “ripple up and down of lights”, turn off the controller, allow the joystick to return to the neutral position, then turn on the controller.

NOTE: If you still get “ripple up and down of lights”, contact your authorized Pride provider.

NOTE: When the batteries approach a discharged state, the first red light will begin to slowly flash, reminding you the batteries need to be charged immediately!

Speed/Profile Keys

There are two keys that control either the speed or the profile. See figure 18. This depends on how your VSI was programmed. Press the speed/profile increase key to increase the speed or change the profile. Press the speed/profile decrease key to decrease the speed or change the profile. The speed/profile setting is displayed on the maximum speed/profile indicator. If your power chair was programmed with a drive profile, contact your authorized Pride provider for more information.

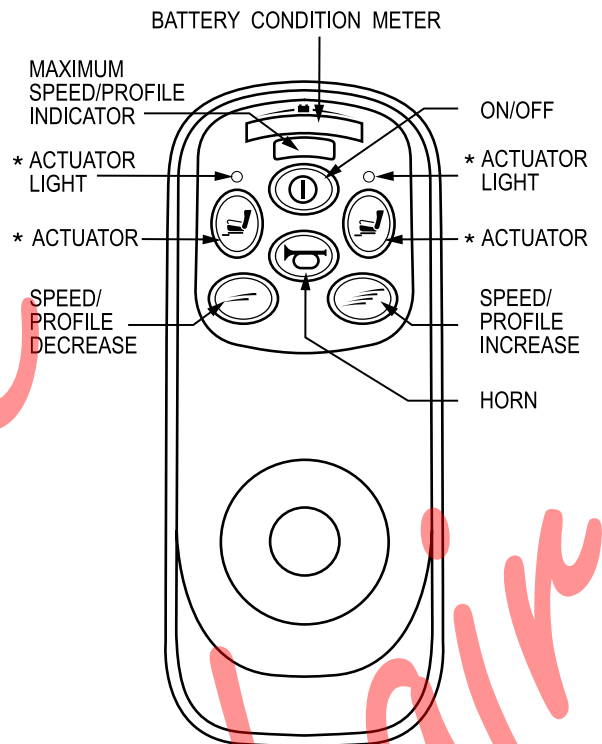

Figure 18. VSI Controller Keypad

VIII. OPERATION

NOTE: We recommend that the first few times you operate your power chair, you set the speed to the slowest setting until you become familiar with your new power chair.

Actuator Key and Actuator Lights (for optional equipment)

Actuator keys and actuator lights are used for optional equipment such as power elevating seats or power elevating leg rests. For specific operation of the actuator keys and actuator lights, contact your authorized Pride provider.

Horn Key

The horn key activates the horn.

Off-board Charger/Programming Socket

You may use an off-board charger to charge the power chair batteries through the 3-pin socket located on the front of the VSI. See figure 17. If you use an off-board charger, the charger current should not exceed 12 amps. Contact your authorized Pride provider for more information.

NOTE: The socket may also be used for reprogramming the VSI. Contact your authorized Pride provider for more information.

Controller Connector

This connects the VSI to the power chair's batteries, motors, and motor brakes.

3-pin Charger Inhibit Connector

This connects the VSI to the onboard battery charger. This connection provides an inhibit that disables the VSI when the battery charger is on. The charger inhibit connector is coded with colored dots. The dots are positioned so that you align the flat side of the male connector with the flat side of the female connector before making the connection.



CAUTION! Failure to properly align the connectors can result in damage to the VSI, the charger, and the connectors.

Thermal Rollback

The VSI controller is equipped with a thermal rollback circuit. The circuit monitors the temperature of the controller, which roughly translates to motor temperature. In the event that the VSI controller becomes excessively hot (above 140° F), motor current (amperage) is reduced. For every degree above 140° F, the motor current limit is reduced by .55 amps until the VSI controller reaches 158° F, at which time the current output is reduced to zero. This reduces your power chair's "power," which could also reduce your power chair's speed, and allows the electrical components and motors to cool down. When the temperature returns to a safe level, your power chair resumes its normal operation.

VIII. OPERATION

Troubleshooting

The VSI controller is designed with the user's safety as the prime consideration. It incorporates many sophisticated self-test features which search for potential problems at a rate of 100 times per second. If the VSI detects a problem either in its own circuits or in the power chair's electrical system, it may stop the power chair, depending on the severity of the problem. The VSI is designed to maximize the user's safety under all normal conditions. The table below identifies the individual error codes. Error codes are displayed as a rapid flashing of the lights. If you get one of these error codes, contact your authorized Pride provider.

VSI Error Codes

FLASHING LIGHTS	DIAGNOSIS AND SOLUTION
1	The battery needs charging or there is a bad connection to the battery. Check the connections to the battery. If the connections are good, try charging the battery.
2	The left motor has a bad connection. Check the left motor connection.
3	The left motor has a short circuit to a battery connection. Contact your authorized Pride provider.
4	The right motor has a bad connection. Check the right motor connection.
5	The right motor has a short circuit to a battery connection. Contact your authorized Pride provider.
6	The power chair is being inhibited by the battery charger. Unplug the battery charger.
7	A joystick fault is indicated. Make sure that the joystick is in the neutral (center) position before turning on the controller.
8	A control system fault is indicated. Make sure that all connections are secure.
9	The parking brakes have a bad connection. Check the parking brake and motor connections. Make sure the controller connections are secure.
10	An excessive voltage has been applied to the controller. This is usually caused by a poor battery connection. Check the battery connections.

VIII. OPERATION

PILOT CONTROLLER

The electronic controller is what you use to operate your power chair. It takes the battery voltage and sends it to the appropriate system. The electronic controller also enables you to monitor battery charge, electronic controller functions, and the condition of your electrical system. Also, it may be used to control some optional systems such as power elevating seats and lights.

The Pilot electronic controller is an integral electronic controller. All of the electronics necessary to operate the power chair are contained in one module. See figure 19.

The Pilot consists of:

1. joystick
2. on/off button
3. battery condition meter
4. speed control knob
5. off-board charger/programming socket
6. controller connector
7. 3-pin charger inhibit connector

Typically, the Pilot is mounted to one of the armrests and is connected to the motors, batteries, and the onboard charger at the electronics tray.

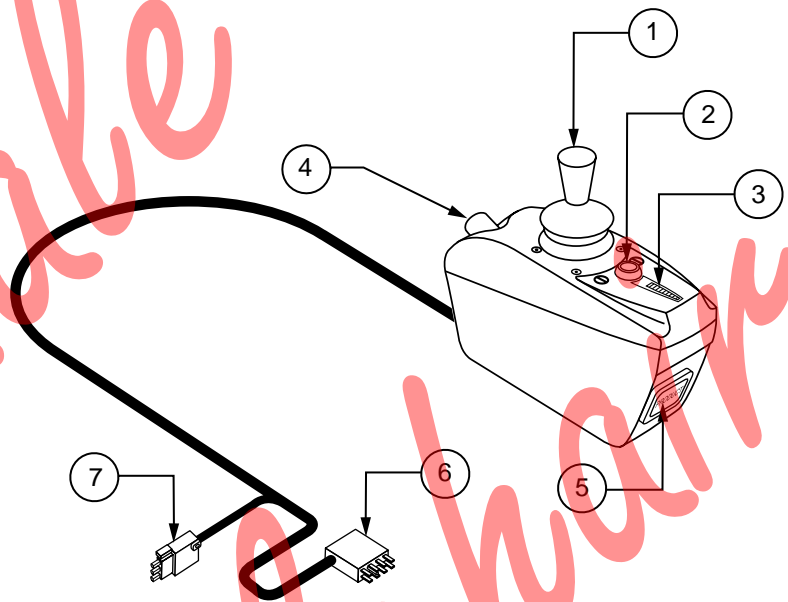

Figure 19. The Pilot Controller

Joystick

The joystick controls the direction and speed of your power chair. When you move the joystick from the neutral (center) position, the electromagnetic brakes release and allow your power chair to move. The further you push the joystick from its neutral position, the faster your power chair moves. When you release the joystick and allow it to return to the neutral position, you engage the electromagnetic brakes. This causes your power chair to decelerate and come to a complete stop.



WARNING! If your power chair begins to move in an unexpected manner, immediately release the joystick. Unless the joystick is damaged, this action should stop your power chair.

On/Off Button

This is a green button located in front of the joystick. It turns the Pilot on and off.



WARNING! Unless faced with an emergency situation, do not use the on/off push button to stop the chair. This will cause the power chair to stop abruptly.

WARNING! Always turn the power off when you are stationary to prevent unexpected movement.

VIII. OPERATION

Battery Condition Meter

The battery condition meter is located in front of the joystick. This is a 10-segment illuminated display that indicates that the Pilot is turned on and also gives the battery status, the Pilot status, and the electrical system status.

- **Red, yellow, and green lights lit:** Battery charged; Pilot and electrical system OK.
- **Red and yellow lights lit:** Charge battery if possible; Pilot and electrical system OK.
- **Red lights only lit or slow flash:** Charge battery as soon as possible; Pilot and electrical system OK.
- **Rapid flash of lights:** Indicates a fault in the Pilot or the electrical system. Refer to “Pilot Error Codes.”
- **Ripple up and down of lights:** The joystick was not in the neutral position when the controller was turned on. If you get “ripple up and down of lights”, turn off the controller, allow the joystick to return to the neutral position, then turn on the controller.

NOTE: If you still get “ripple up and down of lights”, contact your authorized Pride Provider.

NOTE: When the batteries approach a discharged state, the first red light will begin to slowly flash, reminding you the batteries need to be charged immediately!

Speed Control Knob

Sets the maximum speed of the power chair: clockwise to increase, counterclockwise to decrease.

NOTE: We recommend that the first few times you operate your power chair, you turn the speed control to the slowest setting until you become familiar with your new power chair.

Off-board Charger/Programming Socket

You may use an off-board charger to charge the power chair batteries through the 3-pin socket located on the front of the Pilot. If you use an off-board charger, the charger current should not exceed 12 amps. Contact your authorized Pride provider for more information.



CAUTION! Only chargers with Neutrik NC3MX plugs should be connected to the offboard charger/programming socket. See your authorized Pride provider for more information.

NOTE: The offboard charger/programming socket may also be used for reprogramming the Pilot. Contact your authorized Pride provider for more information.

Controller Connector

This connects the Pilot to the power chair’s batteries, motors, and motor brakes.

3-pin Charger Inhibit Connector

This connects the Pilot to the onboard battery charger. This connection provides an inhibit that disables the Pilot when the battery charger is on. The charger inhibit connector is coded with colored dots. The dots are positioned so that you align the flat side of the male connector with the flat side of the female connector before making the connection.



CAUTION! Failure to properly align the connectors can result in damage to the Pilot, the charger harness, and the connectors.

VIII. OPERATION

Thermal Rollback

The Pilot is equipped with a thermal rollback circuit. This circuit monitors the temperature of the motors and the Pilot. In the event that either one of the motors or the Pilot becomes excessively hot (above 122° F), the Pilot reduces the motor voltage. For every degree above 122° F, the controller reduces the voltage by 5 volts. This reduces your power chair's speed and allows the electrical components to cool down. When the temperature returns to a safe level, your power chair resumes its normal speed.



WARNING! Under strenuous driving conditions, it is possible for the bottom and side case temperature of the Pilot to exceed 105° F. DO NOT touch the side or bottom of the Pilot case under these circumstances.

Trouble Codes

In addition to indicating the current state of battery charge, the battery condition meter can also indicate possible problems with your power chair. The battery condition meter has ten lights. The lights provide information by the number of lights that are flashing. If any of the meter lights are flashing rapidly, the controller may be indicating a fault. For instance, if the first light is flashing rapidly, the battery voltage is nearly depleted. The following is a list of the possible errors signified by the rapidly flashing meter. When you get a trouble code, contact your authorized Pride provider.

FLASHING LIGHTS	DIAGNOSIS	SOLUTION
10	High Battery Voltage	Check batteries.
9	Solenoid Brake Fault	Check motor/brake wiring.
8	Possible Controller Fault	See authorized Pride provider.
7	Possible Joystick Fault	See authorized Pride provider.
6	Inhibit Active	Unplug charger. Check connections.
5	Right Motor Wiring Fault	Check right motor wiring.
4	Right Motor Disconnected	Check right motor wiring.
3	Left Motor Wiring Fault	Check left motor wiring.
2	Left Motor Disconnected	Check left motor wiring.
1	Low Battery Voltage	Check batteries/battery wiring.

IX. CARE AND MAINTENANCE

Your Jet 3 is a sophisticated power chair. Like any motorized vehicle, it requires routine maintenance. You can perform some of these checks. Others require assistance from your authorized Pride provider. Preventive maintenance is very important. If you follow the maintenance checks in this section as scheduled, you can help ensure that your Jet 3 gives you years of trouble-free operation. If you have any doubt as to your Jet 3's care or operation, contact your authorized Pride provider.



WARNING! Your Jet 3, like most electrical/mechanical equipment, is susceptible to damage from the elements. Avoid damp areas of any kind. Direct exposure to water or dampness could cause the power chair to malfunction electronically and mechanically. Water can cause electrical components to corrode and the frame to rust.

Should your Jet 3 come in contact with water:

1. Use a towel to dry your Jet 3 as much as possible.
2. Allow your Jet 3 to sit in a warm, dry place for 24 hours to allow unseen water to evaporate.
3. Perform all safety and operational tests before using your Jet 3 again.
4. If any inconsistencies are found, contact your authorized Pride provider.

TEMPERATURE

Some parts of your Jet 3 are susceptible to extreme changes in temperature.

- In extremely cold temperatures, the batteries may freeze. The specific temperature at which they will freeze depends on a number of factors, such as battery charge, usage, and composition of the batteries (e.g., sealed lead-acid or gel cell).
- Temperatures above 122°F may cause the Jet 3 to operate at a reduced speed. This is a safety feature built into the controller that helps prevent damage to the motor and other electrical components. See VIII. "Operation."

GENERAL GUIDELINES

- Avoid knocking or bumping your controller, especially the joystick.
- Avoid prolonged exposure of your Jet 3 to extreme conditions, such as heat, cold or moisture.
- Keep the controller clean.
- Check all connections on the electronics connector housing to ensure that they are all tight and properly secured. Also check the charger harness connector.
- When the battery condition meter is completely lit, the batteries are fully charged and the controller and electrical system are OK.
- If one red LED on the battery condition meter is blinking slowly, the batteries are low and need to be charged, but the controller and electrical system are OK.
- If the battery condition meter is blinking rapidly, the controller has detected a fault either in its own circuits or in the Jet 3's circuits. See VIII. "Operation."
- Make sure the drive tires are inflated to 30 - 35 psi.



WARNING! Make sure your tires are inflated to 30 - 35 psi. Do not under or overinflate your tires. Underinflation may result in loss of control and overinflated tires may burst. Serious personal injury may result. Overinflating tires can cause them to explode and can result in personal injury.

WARNING! Do not use a high pressure hose to inflate your tires.

- Use a rubber conditioner on the tire sidewalls to help preserve them. Check the tires for wear.

IX. CARE AND MAINTENANCE



WARNING! Never use a rubber conditioner on the tread area of the tires; doing so may make the tires slippery and cause your Jet to skid.

- The body shroud has been sprayed with a clear sealant coating. You can apply a light coat of car wax to help it retain its high-gloss appearance.
- Check all electrical connections. Make sure they are tight and are not corroded. Batteries must sit flat within the battery area, with the battery terminals facing inward toward each other. Refer to the frame decal for the correct wiring layout.
- All wheel bearings are prelubricated and sealed. They require no subsequent lubrication.

DAILY CHECKS

- With the controller turned off, check the joystick. Make sure it is not bent or damaged and that it returns to center when you release it. Check the rubber boot around the base of the joystick for damage. Visually inspect the boot only. Do not handle or try to repair it. See your authorized Pride provider if there is a problem.
- Visually inspect the controller harnesses. Make sure that they are not frayed or cut or have any wires exposed. See your authorized Pride provider if there is a problem with any of these harnesses.

WEEKLY CHECKS

- Disconnect the controller and charger harnesses from the electronics connector housing and inspect the connections. Look for corrosion. Contact your authorized Pride provider if necessary.
- Ensure that all parts of the controller system are securely fastened to your Jet 3. Do not overtighten any screws.
- Check for proper tire inflation. There should be **30 - 35 psi** in each tire. If a tire will not hold air, see your authorized Pride provider for replacement of the tube.
- Check the brakes. This test should be carried out on a level surface with at least three feet of clearance around your Jet 3.

To check the brakes:

NOTE: The Jet 3 may move when performing this test.

1. Turn on the controller and turn down the speed and response adjustment knob.
2. After one second, check the battery condition meter. Make sure that it remains on.
3. Slowly push the joystick forward until you hear the park brakes click. Immediately release the joystick. You must be able to hear each park brake operating within a few seconds of joystick movement.
4. Repeat this test three times, pushing the joystick backwards, left, and right.

MONTHLY CHECKS

- Check that the anti-tip wheels are not rubbing the ground when you are operating the Jet 3. Adjust them as necessary. See V. "Comfort Adjustments."
- Check for extreme wear on the front anti-tip wheels. Replace them as necessary.
- Check for drive tire wear. See your authorized Pride provider for repair.
- Check the rear casters for wear. Replace them as necessary.

IX. CARE AND MAINTENANCE

- Check the rear forks for damage or fluttering, which indicates that they may need to be adjusted or that the bearings may need to be replaced. See your authorized Pride provider for the repair or replacement.
- Keep your Jet 3 clean and free of foreign material such as hair, food, drink, residue, etc.

YEARLY CHECKS

Take your Jet 3 to your authorized Pride provider for yearly maintenance. This will help ensure that your Jet 3 is functioning properly and help prevent future complications.

STORAGE

Your power chair should be stored in a dry place not subject to temperature extremes. When storing, disconnect the batteries from the Jet 3. See VII. "Batteries and Charging" for complete instructions.



WARNING! If you fail to store the unit properly, the frame can rust and the electronics can be damaged.

CLEANING INSTRUCTIONS



CAUTION! Never hose off your Jet or place it in direct contact with water. Your Jet has a painted, ABS plastic body shroud that allows it to be easily wiped clean with a damp cloth.

CAUTION! Never use any chemicals to clean a vinyl seat, as they may cause the seat to become slippery or dry out and crack. Use soapy water and dry the seat thoroughly.

TIRES AND TUBES

If your Jet 3 is equipped with pneumatic tires, you should check the air pressure at least once per week. This will prolong the life of your tires as well as help ensure the perfect operation of your chair. If you have a flat tire, replace the tube. Replacement tires and tubes are readily available at your authorized Pride provider.



WARNING! To avoid possible injury, be sure that the controller's power is turned off and the power chair is not in freewheel mode before performing this procedure.

WARNING! Completely deflate the tire before attempting repair.

Follow these easy steps for a quick & safe tube or tire replacement:

1. Completely deflate the tire (if pneumatic).
2. Use a 17 mm socket to remove the nut and washer from wheel axle.
3. Pull the wheel off of the axle.
4. Use a 5 mm hex key to remove the five bolts that hold the two-piece wheel together. The rim will separate into two pieces.
5. Remove the old tube and/or tire and replace it with a new tube and/or or tire.
6. Place the rim halves together and reinstall the bolts.
7. Slide the wheel back onto the shaft, reinstall the washer, and tighten the nut.
8. Inflate a pneumatic tire to **30 - 35 psi**.

IX. CARE AND MAINTENANCE

BATTERY REPLACEMENT



WARNING! Battery posts, terminals, and related accessories contain lead and lead compounds. Wear goggles and gloves when handling batteries and wash hands after handling.

WARNING! Pride Power Chair batteries are heavy. See specifications table. If you are unable to lift that much weight, be sure to get help. Lifting beyond your capacity can result in personal injury.

To replace the battery:

1. Turn the power off.
2. Unplug the controller wire harness. See VI. "Disassembly."
3. Remove the seat.
4. Remove the body shroud.
5. Ensure the Jet 3 is not in freewheel mode. See IV. "The Jet 3."
6. Locate the two wiring harnesses attached to your batteries. Disconnect these two harnesses from their respective quick disconnects. See figures 20. A diagram is located on a decal on the Jet 3 frame near the battery tray.

NOTE: It is easier to connect the harnesses from the batteries when you have the batteries away from your Jet 3. This gives you more room to work. See figures 21 and 22.

7. Connect the wire labeled REAR BATTERY (+) to a battery's positive (red) terminal. Connect the wire labeled REAR BATTERY (-) to the negative (black) terminal. See figure 23. Install the battery in the rear of your Jet 3's battery tray with the battery terminals facing inward, toward the center of the Jet 3. Plug the wiring harness into a quick disconnect.
8. Connect the wire labeled FRONT BATTERY (+) to the other battery's positive (red) terminal. Connect the wire labeled FRONT BATTERY (-) to the negative (black) terminal. See figure 23. Install the battery in the front of your Jet 3's battery tray with the battery's terminals facing inward, toward the center of the Jet 3. Plug the wiring harness into a quick disconnect.



WARNING! Make sure you tighten the fasteners so that the connections are secure.

9. Dispose of your old batteries in accordance with local disposal laws.



Figure 20. Quick Disconnect

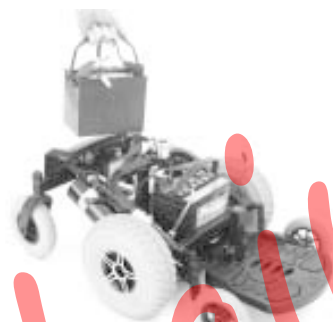

Figure 21. Removing The Batteries From Your Jet 3

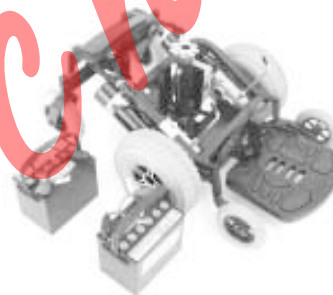

Figure 22. Batteries Removed From Your Jet 3



Figure 23. Connecting Wires To The Battery Terminal

IX. CARE AND MAINTENANCE

MOTOR BRUSHES

The electric motors that power your Jet 3 use carbon brushes. These brushes are susceptible to wear over a long period of time. If worn, the motor brushes run poorly or not at all.



CAUTION! If inspection determines excessive wear on the brushes, they must be replaced or motor damage will result. Failure to maintain the brushes could void the warranty.

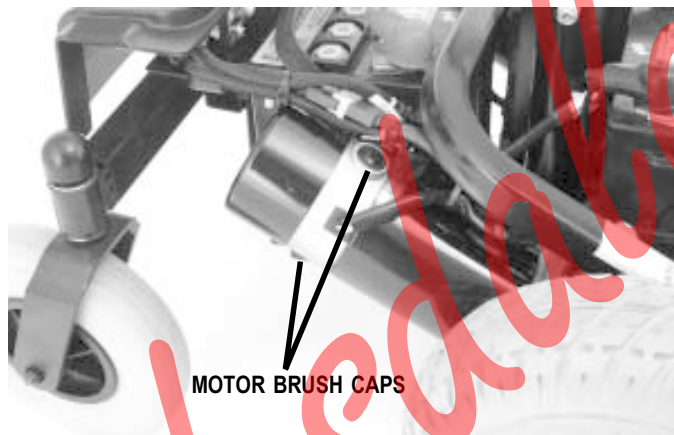

Figure 24. Motor Brush Caps

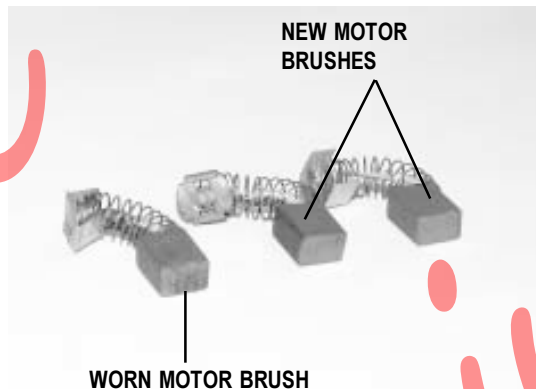

Figure 25. Motor Brushes

To inspect or replace the motor brushes:

1. Remove the seat and the body shroud. See VI. "Disassembly."
2. Unscrew the motor brush caps. See figure 24.
3. Remove the brushes.
4. Inspect the brushes for wear. See figure 25.
5. Replace the brushes if necessary. Contact your authorized Pride provider for replacement brushes.

CORRECTIVE MAINTENANCE

If the battery condition meter does not light up:

- Check the harness connections. Make sure they are tight.
- Check the circuit breaker. Reset it if necessary.
- Check the battery connections.

If the above checks prove normal, you can load test the batteries with a battery load tester. These testers are available at automotive parts stores. Disconnect both batteries before load testing and follow the directions that came with the load tester. If either one of the battery fails the load test, replace both of them. If your Jet 3 still does not power up, contact your authorized Pride provider.

IX. CARE AND MAINTENANCE

WHEN TO SEE YOUR AUTHORIZED PRIDE PROVIDER FOR SERVICE

The following symptoms could indicate a serious problem with your Jet 3. If necessary, contact your authorized Pride provider. When calling, have ready the model number, the serial number, the nature of the problem, and the trouble code if available.

- Motor noise
- Frayed harnesses
- Cracked or broken connectors
- Uneven wear on any of the tires
- Jerky motion
- Pulling to one side
- Bent or broken wheel assemblies
- Does not power up
- Powers up, but does not move

Nithsdale
Wheelchairs

X. OPTIONS AND ACCESSORIES

The following accessories are available from your authorized Pride provider.

OXYGEN TANK HOLDER

The removable oxygen tank holder is mounted to the back of the seat by means of the accessory bracket.

WALKER HOLDER

The removable walker holder is mounted to the back of the seat by means of the accessory bracket. It can hold a standard size walker.

CANE AND CRUTCH HOLDER

The removable cane and crutch holder is mounted to the back of the seat by means of the accessory bracket.

REAR BASKET

The rear basket is mounted to the accessory bracket. It has a handle that can be used when removing the basket from the Jet 3.

CUP HOLDER

The cup holder is mounted to the armrest.

SWING-AWAY JOYSTICK BRACKET

This option enables you to move the joystick from the front of the armrest to the side of the armrest, without disconnecting it.

ELEVATING LEG RESTS

Elevating Leg Rests (ELRs) provide the Jet 3 with the ability to support each leg individually. Each ELR has a wide range of angle and foot plate-length adjustments.

SWING-AWAY LEG RESTS

Swing-away Leg Rests provide the Jet 3 with the ability to swing each leg rest to the side to aid in mounting and dismounting the Jet 3.

SPECIALTY SEATING SYSTEMS

Your Jet 3 may be equipped with specialty seating or with the Versa Seat. Please refer to the instructions that come with the seat.

XI. WARRANTY

FIVE-YEAR LIMITED FRAME WARRANTY

There will be a five-year limited frame warranty on Pride workmanship.

ONE-YEAR LIMITED WARRANTY

For one (1) year from the date of purchase, Pride will repair or replace at our option to the original purchaser free of charge, any of the following parts found upon examination by an authorized representative of Pride to be defective in material and/or workmanship:

- Electronic controllers and joystick assemblies
- Motor/gearbox assembly
- Main frame subassemblies (fork, caster beams, metal seat base, metal arms, metal foot plate)
- Plastic components except body
- Rubber components
- Bearings and bushings
- Caster and anti-tip wheels

WARRANTY EXCEPTIONS

Motor: The motor commutator is not warranted if damage is caused by not replacing the motor brushes if they are worn heavily. Motor brushes are wear items and are not warranted.

Brake: There is a one-year warranty for the electrical function of the brakes. Brake pads are wear items and are not warranted.

Battery: The battery is covered by a separate six-month warranty, given by the battery manufacturer. The battery is not warranted by Pride.

Warranty service can be performed by your authorized Pride provider. Do not return faulty parts to Pride without prior consent. All transportation costs and shipping damage incurred while submitting parts for repair or replacement are the responsibility of the purchaser.

XI. WARRANTY

WARRANTY EXCLUSIONS

- ABS plastic body shrouds and footrest covers are wear items and not warranted.
- Batteries (battery manufacturer provides a six-month limited warranty)
- Tires and tubes
- Upholstery and seating
- Repairs and/or modifications made to any part without specific prior written consent from Pride
- Circumstances beyond the control of Pride
- Labor, service calls, shipping, and other charges incurred for repair of the product unless specifically authorized by Pride

Damage caused by:

- Battery fluid spillage or leakage
- Abuse, misuse, accident, or negligence
- Improper operation, maintenance, or storage
- Commercial use, or use other than normal

There is no other express warranty.

Implied warranties, including those of merchantability and fitness for a particular purpose, are limited to one (1) year from the date of purchase and/or to the extent permitted by law. Any and all implied warranties are excluded. This is the exclusive remedy. Liabilities for consequential damages under any and all warranties are excluded.

Some states do not allow limitations on how long an implied warranty lasts or do not allow the exclusion of limitation of incidental or consequential damages. The above limitation or exclusion may not apply to you.

This warranty gives you specific rights, and you may also have other rights which vary from state to state.

Please fill out and return the warranty card to Pride. This will aid Pride in providing the best possible technical and customer service.

NOTES

Nithsdale
Wheelchairs

JET 3

Power Chairs

Quality Control - Model JET 3



Thank you for making the Jet 3 your choice in power chairs.

We have thoroughly inspected your Jet 3. The following checkmarks indicate that it has been driven and inspected.

Model # _____

Serial # _____



Controller

Controller Serial # _____

Inclusion of all Parts

Performance

Pride keeps a more detailed report on file at the factory.

Nithsdale Wheelchairs

Date Inspected

Inspector